



## **Cessna Single Engine High Wing Maintenance Equipment & Furnishings/Fire Protection**



# CESSNA SINGLE ENGINE HIGH WING MAINTENANCE

FOR TRAINING PURPOSES ONLY

## Revision Record

Rev Year	Rev Number	Rev Date	Revision Details	Reference	Revised by
2016	00	5/13/2016	Original Issue	172S Maintenance Manual, Rev 21, 01OCT15	
2016	01	8/12/2016	Model 182/206 Differences added	182 & 206 Maintenance Manual Rev 19, 01OCT15	Zimmerman

Export Classification C, ECCN EAR99

**WARNING** - This document contains technical data whose export is restricted by the Arms Export Control Act (Title 22, U.S.C., Sec 2751, et. seq.) or the Export Administration Act of 1979, as amended, Title 50, U.S.C., App. 2401 et. seq. Violations of the export laws are subject to severe criminal penalties. Disseminate in accordance with provisions of DoD Directive 5230.25.

**Contents**

ATA25 & ATA26 - Equipment & Furnishings/Fire Protection..... 4

    Overview..... 4

    Seats, Seat Belts/Harnesses (25-00-00) ..... 6

    Flight Compartment Maintenance Practices (25-10-00) ..... 8

    Emergency Locator Transmitter (25-60-01)..... 27

ATA26 Fire Protection..... 59

Equipment & Furnishings/Fire Protection Review..... 63

Model Differences ..... 64

## ATA25 & ATA26 - Equipment & Furnishings/Fire Protection

### Overview

#### LESSON OBJECTIVES

- Identify safety precautions related to equipment and furnishings.
- Identify maintenance practices important to equipment and furnishings.
- Describe the general layout of equipment and furnishings.
- Identify safety precautions related to fire protection system.
- Identify maintenance practices important to the fire protection system.
- Describe the general layout of the fire protection system.

## EQUIPMENT AND FURNISHINGS - SYSTEM OVERVIEW



Chapter 25 of the Maintenance Manual describes the interior equipment and furnishings in the airplane. This chapter covers the maintenance procedures for the seats in the flight compartment and passenger compartment and the seat belts and harnesses.

The chapter also covers the interior upholstery, cargo tie-downs, soundproofing and insulation, the carbon monoxide detector, and the Emergency Locator Transmitter (ELT).

Refer to the Maintenance Manual (25-00-00) for a list of tools, equipment, and materials required to maintain the airplane interior and emergency equipment.

## Seats, Seat Belts/Harnesses (25-00-00)

The seating arrangement consists of two vertically adjusting crew seats for the pilot and front seat passenger and a single bench seat with adjustable back for rear seat passengers. Seats used for the pilot and front seat passenger are adjustable forward and aft, and up and down. Additionally, the angle of the seat back is infinitely adjustable.

- Using the handle located below the center of the seat frame will adjust forward and aft movement.
- To position the seat, lift the handle, slide the seat into position, release the handle and check that the seat locks in place.
- To adjust the height of the seat, rotate the large crank under the right corner of the seat.
- To adjust the seat back angle, pull up on the release button, located in center front of seat, just under the seat bottom, position the seat back to the desired angle, and release the button.

When the seat is empty, the seat back automatically folds forward when the release button is pulled up.

The rear passenger seat consists of a fixed, one piece seat bottom and a three-position reclining back. The reclining back adjusts by a lever located below the center of the seat frame. To adjust the seat back, raise the lever, position the seat back to the desired angle, release the lever, and check that the seat back locks in place.

Headrests are on both the front and rear seats. To adjust the headrest, apply enough pressure to it to raise or lower it to the desired level.



## SEAT BELT / SHOULDER HARNESS - DESCRIPTION AND OPERATION (25-00-00)

All seat positions are equipped with integrated seat belts/shoulder harness assemblies.

The seats incorporate an overhead inertia reel for the shoulder portion, and a retractor assembly for the lap portion of the belt. This design allows for complete freedom of movement of the upper torso area while providing restraint in the lap belt area.

In the event of a sudden deceleration, reels lock up to provide positive restraint for the user.



In the front seats, the inertia reels are located on the centerline of the upper cabin area. In the rear seats, the inertia reels are located outboard of each passenger in the upper cabin. To use the integrated seat belt/shoulder harness, grasp the link with one hand, and, in a single motion, extend the assembly and insert into the buckle. Positive locking has occurred when you hear a distinctive “snap” sound. Verify proper locking of the lap belt by ensuring that the belts are allowed to retract into the retractors and the lap belt is snug and low on the waist as worn normally during flight.

No more than one additional inch of belt should be able to be pulled out of the retractor once the lap belt is in place on the occupant. If more than one additional inch of belt is pulled out of the retractor, the occupant is too small for the installed restraint system and the seat should not be occupied until the occupant is properly restrained.

To exit, press the release button on the buckle and pull out and up on the harness. Spring tension on the inertia reel will automatically stow the harness.



## Flight Compartment Maintenance Practices (25-10-00)

### FLIGHT COMPARTMENT MAINTENANCE PRACTICES (25-10-00)

- Seats, Seat Belts, Shoulder Harnesses - Maintenance Practices
  - Seat Removal/Installation
  - Shoulder Harness Guide Removal/Installation
  - Seat Rail Removal/Installation
  - Seat Tracks and Stops Inspection
  - Shoulder Harness and Seat Belt Inspection
  - Crew Shoulder Harness and Seat Belt Removal/Installation
  - Map Compartment Removal/Installation
- Inflatable Restraint System - Maintenance Practices
  - Component Cleaning
  - Inspection
  - Disarm/Arm
  - Removal/Installation
  - AmSafe Seatbelt Airbag Diagnostic Check



## FLIGHT COMPARTMENT MAINTENANCE PRACTICES (25-10-00)

For IN-DEPTH explanations of the flight compartment maintenance practice procedures refer to the maintenance manual.

### Seat removal/installation

- Seat removal
- Seat installation

If your airplane has the AmSafe Aviation Inflatable Restraint (AAIR) system, do not perform maintenance on the seats or the seat restraint system unless you first obey all applicable precautions and instructions in the E508804 Supplemental AmSafe Maintenance Manual and the ATA25 Maintenance Manual.



Refer to Inflatable Restraint System - Maintenance Practices.



### INFLATABLE RESTRAINTS

If the airplane has AMSAFE inflatable restraints, do not remove seats with the seat belts buckled or the EMA connected. Damage can occur to the system and an accidental deployment of the system can cause injury.

**FLIGHT COMPARTMENT MAINTENANCE PRACTICES (25-10-00)****SEAT STOPS**

Make sure the seat stops are set correctly. Incorrectly installed seat stops can let the seat move during flight, with the result of serious injury or death.

**Shoulder harness guide removal/installation**

- Shoulder harness guide removal
- Shoulder harness guide installation

**PROCEDURES TYPICAL**

The removal/installation procedures are typical for the pilot and copilot seats.

## FLIGHT COMPARTMENT MAINTENANCE PRACTICES (25-10-00)



### UPHOLSTERY

Make sure you are careful when you lift up the upholstery so you do not cause damage.

## FLIGHT COMPARTMENT MAINTENANCE PRACTICES (25-10-00)

Ref: 5-12-02 maintenance manual. Operation 2 gives a list of item(s), which has all 50-hour interval inspection items and those 100- or 200-hour interval inspection items contained in the engine compartment. Items from other areas are included to meet their required time interval.

During each of the specified inspection tasks, more general inspections of the adjacent areas must be done while access is available. These general inspections are used to find apparent conditions that may need more maintenance.

### Seat Tracks and Stops

Inspect seat tracks for condition and security of installation. Check seat track stops for damage and correct location. Inspect seat rails for cracks. (Every 100 hours)

- Seat rail removal
- Seat rail installation

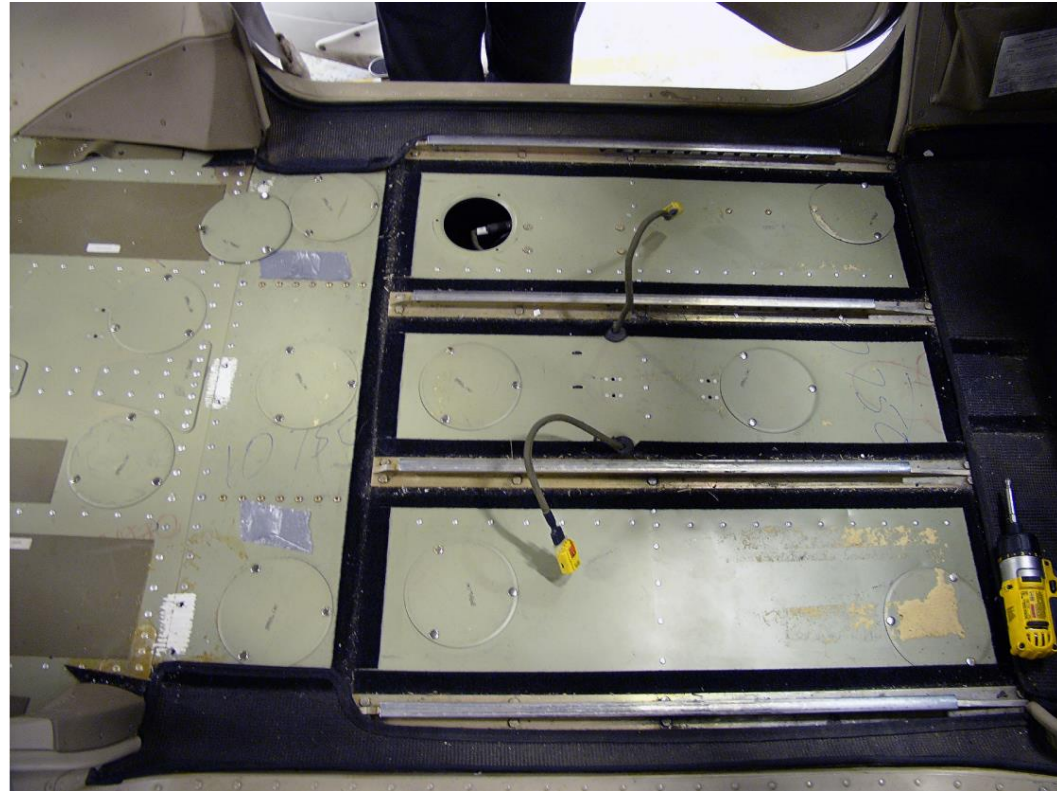

**FLIGHT COMPARTMENT MAINTENANCE PRACTICES (25-10-00)****NOTE****PROCEDURES TYPICAL**

The removal and installation of the shoulder harness and seat belt assembly are typical.

**Shoulder harness and seat belt inspection**

Inspect the shoulder harness and seat belt assembly in accordance with the time intervals in Chapter 5, Inspection Time Limits.

The shoulder harness and seat belt assemblies have a time life associated with them. Refer to Chapter 5, Component Time Life for these limits.

**Crew shoulder harness and seat belt removal/installation**

- Shoulder harness and seat belt assembly removal.
- Shoulder harness and seat belt assembly installation.



## FLIGHT COMPARTMENT MAINTENANCE PRACTICES (25-10-00)



### Map Compartment Removal/Installation

- Map compartment removal.
- Map compartment installation.

## INFLATABLE RESTRAINT SYSTEM - MAINTENANCE PRACTICES (25-10-10)

The AAIR is a self-contained, modular, three-point restraint system that helps to protect occupants from head-impact injury during an accident. The AAIR system has four core components: the air bag assembly, the inflation assembly, the electronics module assembly (EMA), and the cable interface assembly.



### INFLATOR ASSEMBLY

Do not try to open the inflator assembly. Do not apply an electric current to the electronics connection. The inflator assembly is a stored, gas/energetic material device and can cause injury if accidentally deployed.

### Inflatable restraint system component cleaning

AmSafe recommends that the AAIR components be cleaned on a regular (annual) basis. Buildup of dirt and unwanted material can cause problems with system operation, decrease the life of the system, and help cause corrosion of the metal parts in the system. Clean the belt assembly, hoses, cables, inflation device/cap assembly, and the EMA.



**INFLATABLE RESTRAINT SYSTEM - MAINTENANCE PRACTICES (25-10-10)****HARDWARE ASSEMBLIES**

Use care to keep contamination and cleaning agents away from the hardware assemblies.

**AAIR CLEANING**

Do not let any part of the AAIR soak in any solution. This can cause damage to the AAIR system. Do not use too much water when you clean the AAIR parts. Too much water can cause damage to the internal components and cause them to be unserviceable.

**INFLATABLE RESTRAINT SYSTEM - MAINTENANCE PRACTICES (25-10-10)****CLEANING AGENT**

Only use sufficient cleaning agent to make minimal suds. Remove excess soap before the part is installed in the system.

Do not dry the belt assembly in sunlight or near any source of heat. Do not dry clean the belt assembly. Do not put the belt assembly fully into water.

**ISOPROPYL ALCOHOL**

Keep the isopropyl alcohol away from the webbing, air bag cover, and the gas hose material.

**METAL PARTS**

Do not use soap or water on metal parts.

INFLATABLE RESTRAINT SYSTEM - MAINTENANCE PRACTICES (25-10-10)

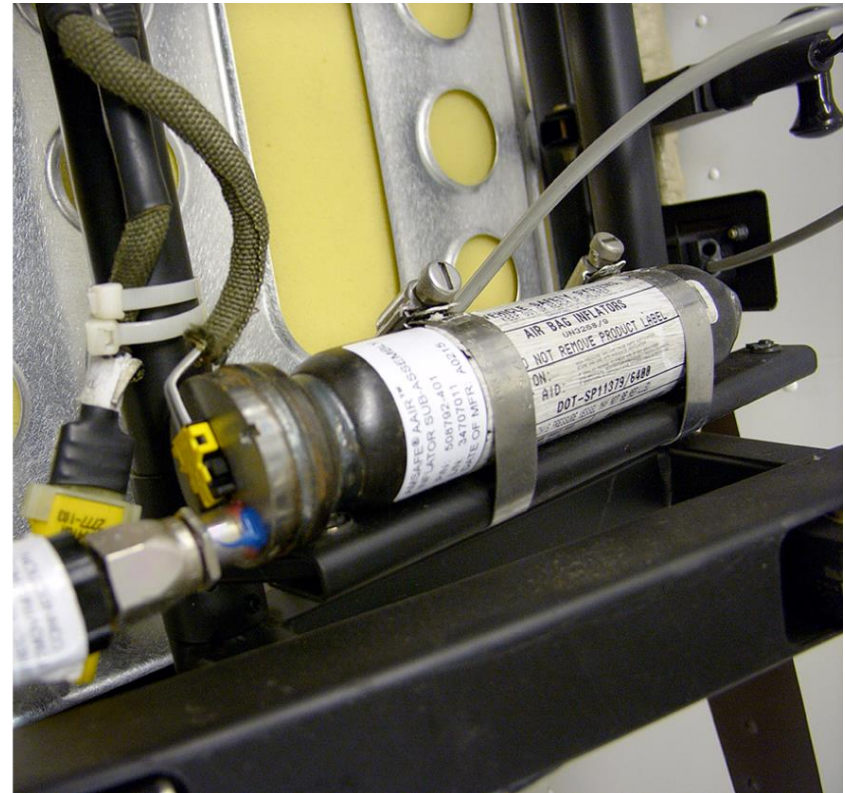
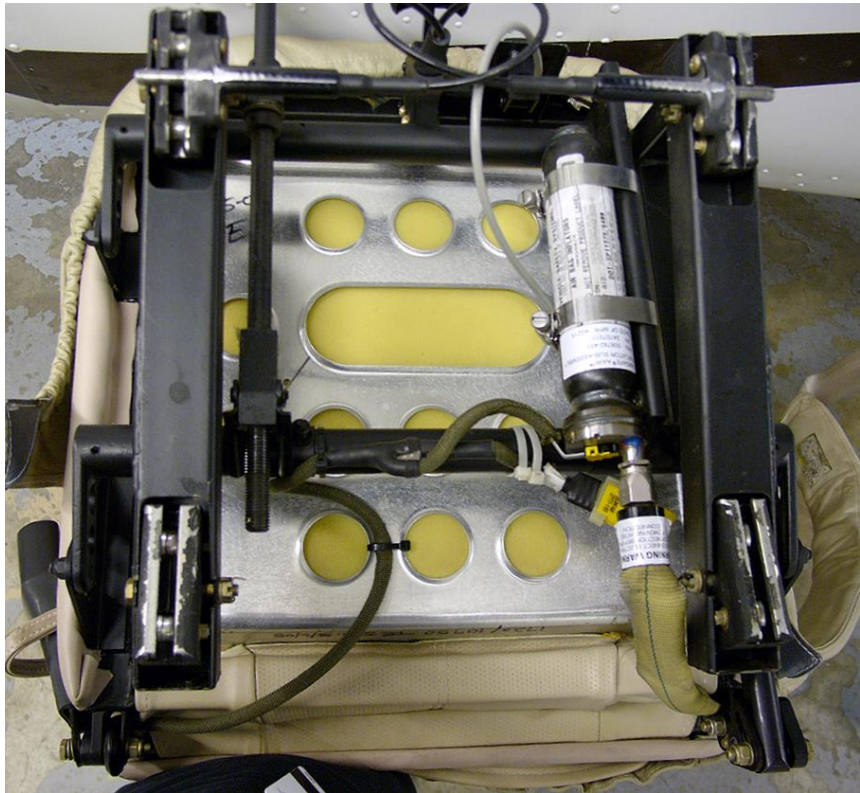

**INFLATABLE RESTRAINT SYSTEM - MAINTENANCE PRACTICES (25-10-10)****NOTE****INFLATOR ASSEMBLY**

The maximum continuous storage time for the inflator assembly is seven years from the date of manufacture. After seven years, send the inflator assembly to AMSAFE Aviation for inspection and repair.

**NOTE****EMA**

The maximum continuous storage time for the EMA is seven years from the date of manufacture. After seven years, send the EMA to AMSAFE Aviation for inspection and repair.

Inflatable restraint system inspection

**INFLATABLE RESTRAINT SYSTEM - MAINTENANCE PRACTICES (25-10-10)****TIME INTERVALS**

The AmSafe Aviation Inflatable Restraint (AAIR) must be examined in accordance with the time intervals in Chapter 5, Inspection Time Limits.

The AmSafe Aviation Inflatable Restraint (AAIR) assemblies have a time life associated with them. Refer to Chapter 5, Component Time Life for these limits.

**Perform an inspection of the AAIR system parts:**

- Air bag assembly
- Inflator hose
- Cable interface assembly
- Inflator assembly
- Electronics Module Assembly (EMA)

## INFLATABLE RESTRAINT SYSTEM - MAINTENANCE PRACTICES (25-10-10)

### Storage of spares

- Inflator assembly
- Electronics Module Assembly (EMA)
- Air bag assembly

### AMSAFE Inflatable Restraint Disarm/Arm

- Disarm the AmSafe inflatable restraints.
- Arm the AmSafe inflatable restraints.

### Inflatable restraint system removal/installation

- Restraint system removal.
- Restraint system installation.



### MAGNETIC FIELDS

Keep all magnetic fields away from the electronics module assembly (EMA) during the removal and installation procedure. Accidental deployment of the system can cause injury.

**INFLATABLE RESTRAINT SYSTEM - MAINTENANCE PRACTICES (25-10-10)****SEAT REMOVAL**

Do not remove seats from the airplane with the seat belts buckled or the EMA connected. Damage can occur to the system and an accidental deployment of the system can cause injury.

**EMA**

Do not connect the EMA to the cable interface assembly unless the EMA is first mounted to the airplane structure. Accidental deployment can cause injury.



## INFLATABLE RESTRAINT SYSTEM - MAINTENANCE PRACTICES (25-10-10)



The AmSafe Seat belt Airbag diagnostic check provides a system functional analysis of the AmSafe Seatbelt Airbag circuits as a whole. Fault isolation of the systems components is accomplished by replace-and-retest method.

The AmSafe Seatbelt Airbag Diagnostic Check should be performed after system installation onto the seat, after installation of the seat into the aircraft, and at a minimum of every 4000 flight-hours.

Diagnostic checks at a shorter interval will not affect system reliability or operation and will not affect operable life of the system.

**INFLATABLE RESTRAINT SYSTEM - MAINTENANCE PRACTICES (25-10-10)****AAIR SYSTEM**

There are two seats in each AAIR system. This functional test must be completed for each AAIR system on the airplane.

**AAIR SYSTEM**

For the second seat location, the 2 LED light will be used to give an indication.

## INFLATABLE RESTRAINT SYSTEM - MAINTENANCE PRACTICES (25-10-10)



For More Information

### **CALIBRATE**

Calibrate the V23 system diagnostic tool again before use if it is:

- Hit
- Shaken
- Falls to the floor

## FLIGHT COMPARTMENT MAINTENANCE PRACTICES (25-10-00) REVIEW

- Seats, Seat Belts, Shoulder Harnesses - Maintenance Practices
  - Seat Removal/Installation
  - Shoulder Harness Guide Removal/Installation
  - Seat Rail Removal/Installation
  - Seat Tracks and Stops Inspection
  - Shoulder Harness and Seat Belt Inspection
  - Crew Shoulder Harness and Seat Belt Removal/Installation
  - Map Compartment Removal/Installation
  
- Inflatable Restraint System - Maintenance Practices
  - Component Cleaning
  - Inspection
  - Disarm/Arm
  
- Removal/Installation
  
- AmSafe Seatbelt Airbag Diagnostic Check

## Emergency Locator Transmitter (25-60-01)

### EMERGENCY LOCATOR TRANSMITTER (ELT) SYSTEM OVERVIEW (25-60-01)

- ELT Description
- ELT Operation
  
- Artex C406-N ELT Maintenance Practices
- ELT Removal/Installation
- ELT Remote Switch Removal/Installation
- ELT Rod Antenna Removal/Installation
- Buzzer Removal/Installation
- Functional Test

#### Artex ME406 ELT

- Components
- Normal Operation
- Operating Limitations

#### Artex ME406 ELT Maintenance Practices

- Troubleshooting
- Inspection
- Functional Test
- Carbon Monoxide Detector Maintenance Practices

## ELT AND CARBON MONOXIDE DETECTOR OVERVIEW

The Artex ME406 Emergency Locator Transmitter (ELT) System is designed to help rescue teams find the airplane in the event of a crash. It operates in a wide range of environmental conditions and is resistant to the forces caused by many types of accidents.

The Artex ME406 Emergency Locator Transmitter (ELT) uses a solid-state 2-frequency transmitter powered by an internal lithium battery.

The ME406 is equipped with an instrument panel mounted remote switch assembly that includes a red warning light, and an external antenna mounted on the top of the tailcone.



The remote switch assembly installed along the upper right instrument panel, controls ELT operating modes from the flight crew station.

- When the remote switch is set to the ARM position, the transmitter is energized only when the internal "G" switch senses longitudinal inertia forces per TSO-C91a/TSO-C126.
- When the remote switch is set to the ON position, the transmitter energizes.

**ARTEX C406-N ELT DESCRIPTION AND OPERATION - (25-60-01)**

The C406-N transmitter unit is located in the tailcone along the right side behind the baggage compartment aft panel. On the ELT transmitter unit is a panel containing an ON/OFF switch and a transmitter warning light.

The ELT installation uses two different warnings to tell the pilot when the ELT energizes.

- The aural warning is an unusual sound that is heard by the pilot.
- The visual flashing red light directly above the remote switch shows the pilot that the ELT has been activated.



**ARTEX C406-N ELT DESCRIPTION AND OPERATION - (25-60-01)**

Check that the remote switch (on the right instrument panel) is set to the ARM position.

**NORMAL PROCEDURES**

When operating in a remote area or over hazardous terrain, it is recommended that the ELT is inspected by an approved technician more frequently than required by 14 CFR 91.207.

**NORMAL OPERATION**

Normal operation of the C406-N from the flight crew station is only to de-energize and arm the ELT after it has been accidentally energized (no emergency). A lightning strike or a hard landing can energize the ELT. If the red light above the remote switch is flashing and the aural warning heard, the ELT is energized.

- Check for the emergency signal on a COM radio set to 121.5 MHz.
- To stop the transmissions, set the remote switch to the ON position momentarily and then set to the ARM position.
- Tell the nearest Air Traffic Control facility about the accidental transmissions as soon as possible to hold search and rescue work to a minimum.

## ARTEX C406-N ELT DESCRIPTION AND OPERATION - (25-60-01)

### PERFORMANCE

With the Artex C406-N installed, there is no change to the airplane performance.

The Artex C406-N Emergency Locator Transmitter (ELT) uses a solid-state 3-frequency transmitter powered by an internal lithium battery. The navigation function of the C406-N ELT receives power from the airplane's main battery thru Avionics Bus 1 and the Essential Bus.

The C406-N is equipped with an instrument panel mounted remote switch assembly that includes a red warning light, and an external antenna mounted on the top of the tailcone. The remote switch assembly installed along the top right side of the instrument panel controls the ELT operating modes from the flight crew station.

When the remote switch is set to ARM, the transmitter energizes when the internal "G-switch" senses longitudinal inertia forces per TSO-C91a/TSO-C126. When the C406-N energizes, the ELT transmits the standard swept tone signal on the international VHF frequency of 121.5 MHz and UHF frequency of 243.0 MHz until battery power is gone. The 121.5 MHz signal pinpoints the beacon during search and rescue operations, and is monitored by general aviation, commercial aircraft, and government agencies. In addition, for the first 24 hours of the energized ELT, a 406.028 MHz signal transmits at 50 second intervals. This transmission lasts 440 milliseconds and contains identification data programmed into the ELT and is received by COSPAS/SARSAT satellites. The transmitted data may include the Aircraft ID, GPS coordinates, ELT Serial Number, Country Code, and COSPAS/SARSAT ID.

## ARTEX C406-N ELT DESCRIPTION AND OPERATION - (25-60-01)

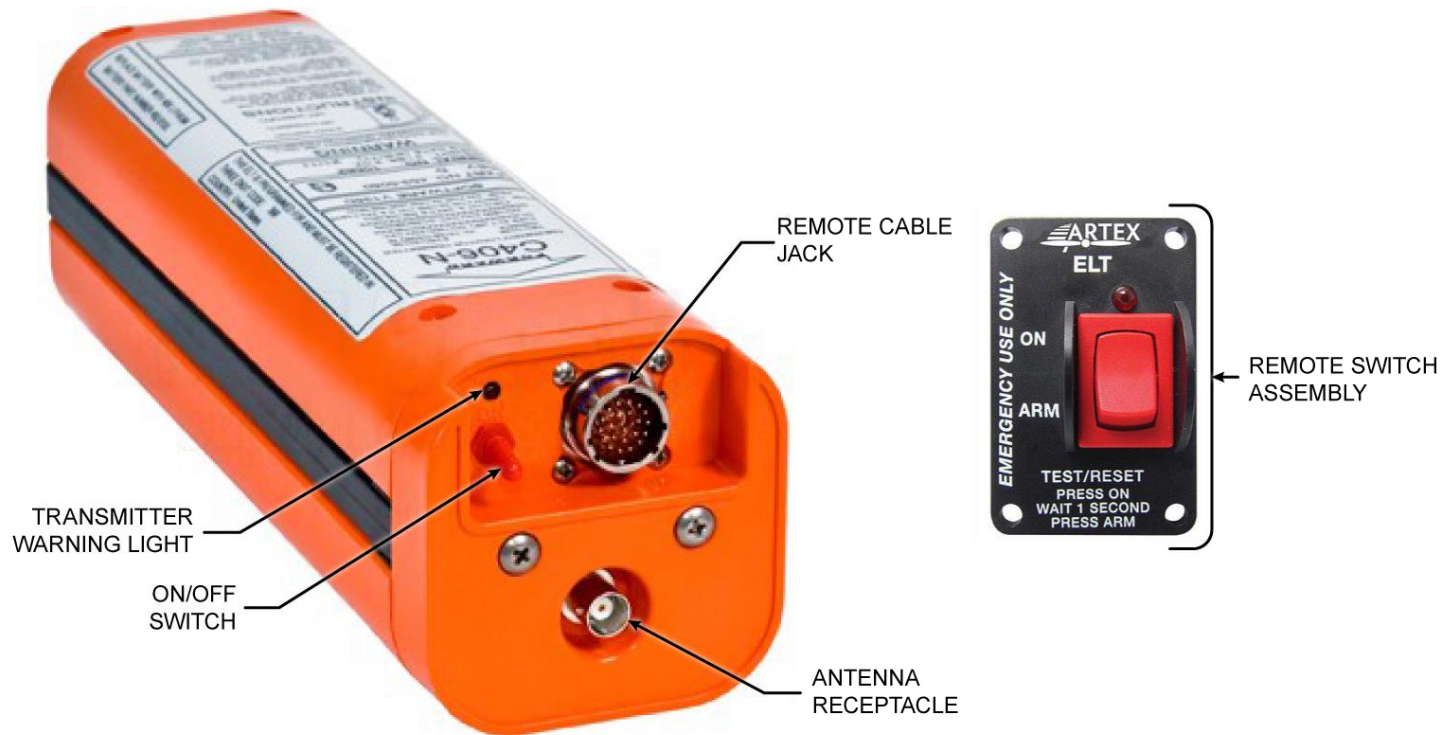
**ELT PANEL SWITCH (Two-Position Toggle Switch):**

- OFF - Turns OFF and ARMS transmitter for automatic activation if “G” switch senses a predetermined deceleration level.
- ON - Activates transmitter instantly. The ON position bypasses the automatic activation switch.
- The RED warning light on the ELT panel and on the remote switch assembly mounted on the instrument panel should come on.

## ARTEX C406-N ELT DESCRIPTION AND OPERATION - (25-60-01)

- **TRANSMITTER WARNING LIGHT**
  - Light comes on RED to indicate the transmitter is transmitting a distress signal.
- **REMOTE CABLE JACK**
  - Connects to the ELT remote switch assembly located on the upper right instrument panel.
- **ANTENNA RECEPTACLE**
  - Connects to the antenna mounted on top of tailcone.
- **REMOTE SWITCH ASSEMBLY - (Two Position Rocker Switch):**
  - ARM (OFF) - Turns OFF and ARMS transmitter for automatic activation if “G” switch senses a predetermined deceleration level.
  - ON - Remotely activates the transmitter for test or emergency situations.
  - The RED warning light above the rocker switch comes on to indicate that the transmitter is transmitting a distress signal.

### OPERATING LIMITATIONS

There are no additional airplane operating limitations with the Artex C406-N ELT installed. The airplane owner or operator must register the C406-N ELT with the applicable civil aviation authority before use to make sure that the identification code transmitted by the ELT is in the COSPAS/SARSAT database. Refer to [www.cospas-sarsat.org](http://www.cospas-sarsat.org) for registration information.

Refer to 14 CFR 91.207 for ELT inspection requirements. Use the correct test equipment under the appropriate civil aviation authorities approved conditions and have the C406-N inspected and tested only by an approved technician.

ARTEX C406-N ELT- MAINTENANCE PRACTICES (25-60-01)

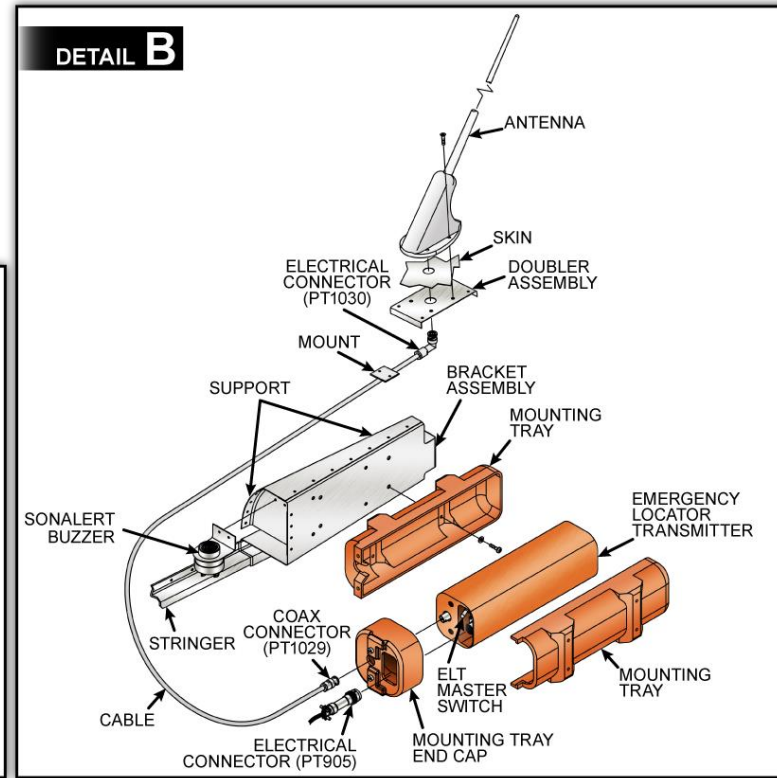
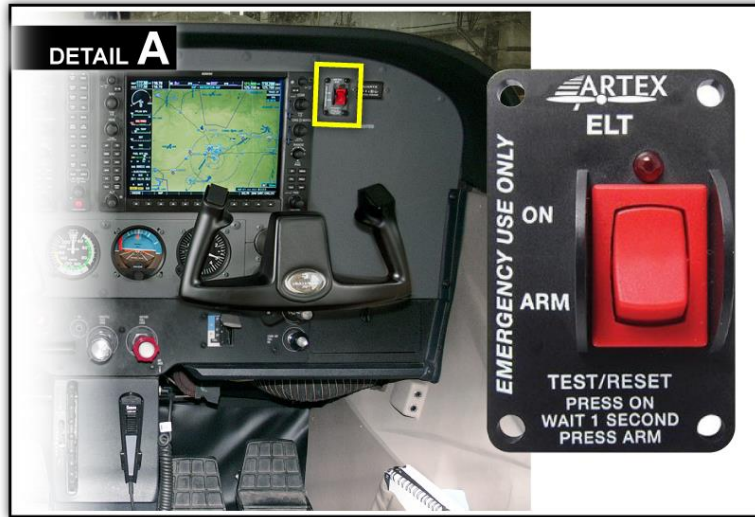
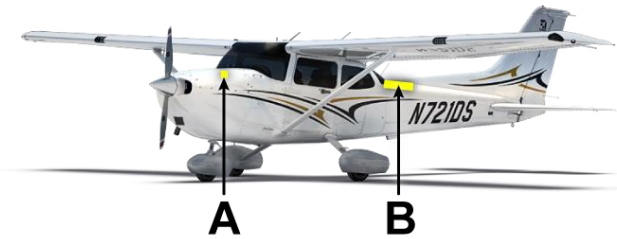

For IN-DEPTH explanations of the ARTEX C406-N locator transmitter maintenance practice procedures refer to the maintenance manual.

## **ARTEX C406-N ELT- MAINTENANCE PRACTICES (25-60-01)**

- **Artex C406-N ELT removal/installation**
  - ELT removal
  - ELT installation
- **ELT remote switch removal/installation**
  - ELT remote switch removal
  - ELT remote switch installation
- **ELT rod antenna removal/installation**
  - ELT antenna removal
  - ELT antenna installation
- **Buzzer removal/installation**
  - Buzzer removal
  - Buzzer installation

## ARTEX C406-N ELT- MAINTENANCE PRACTICES (25-60-01)



### **DIRECTION-OF-FLIGHT ARROW**

Make sure that the direction-of-flight arrow on the ELT points to the nose of the airplane.



### **ELT ROD ANTENNA**

For ELT Rod Antenna Installs, the maximum allowable resistance (in ohms) at each of the four measured positions is 0.0025.



## ARTEX C406-N ELT - INSPECTION / CHECK (25-60-01)



For IN-DEPTH explanations of the ARTEX C406-N locator transmitter inspection / check procedures refer to the maintenance manual.

## ARTEX C406-N ELT - INSPECTION / CHECK (25-60-01)

### Prepare for the Artex C406-N ELT Functional test

- Perform the ELT transmitter test.
- Perform the NAV interface test.
- Perform the G-Switch operational test.



**CAUTION**

### FIRST FIVE MINUTES

Operate the Emergency Locator Transmitter system only during the first five minutes of each hour.

If you must complete the functional test at a time other than the first five minutes of the hour, you must do the test with a direct connection to the ELT and a 30 dB attenuator. Refer to the FAA Advisory Circular AC-91-44A.



**CAUTION**

### FIVE SECONDS

Do not operate the emergency locator transmitter for more than five seconds at a time. Do not operate the ELT again for 15 seconds.

The ELT will transmit a 406.028 MHz signal after the ELT is active for approximately 50 seconds. This signal is identified as a distress signal.

**ARTEX C406-N ELT - INSPECTION / CHECK (25-60-01)****TEST EQUIPMENT**

The SARSAT tester is used as an example to gather test information. However, other equivalent test equipment such as the Aeroflex IFR 4000 Communications Test Set is acceptable.

**JUMPER WIRE**

The ELT will not activate with the G-switch unless electrical pins 12 and 13 have a jumper wire installed between them (this happens automatically when the ELT locks into the mount tray with the electrical connector in position).

Because of the potential physical damage that can occur if the jumper wire is not installed correctly, it is recommended that an experienced technician do this procedure.

## ARTEX ME406 ELT DESCRIPTION AND OPERATION - (25-60-01)

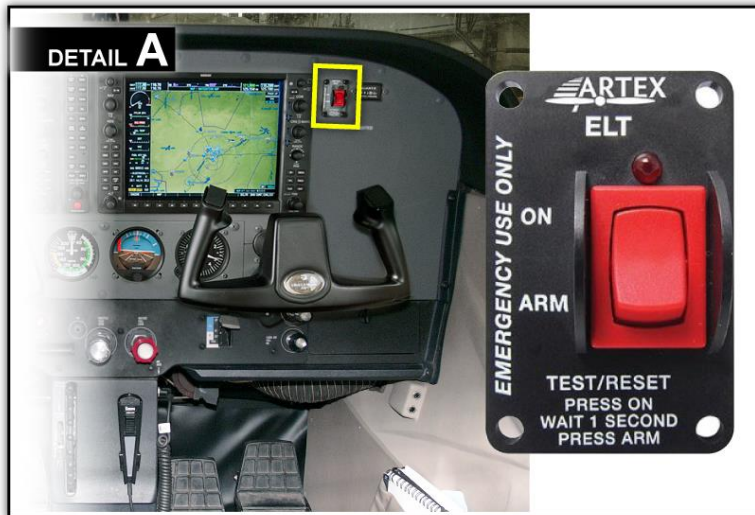

The Artex ME406 Emergency Locator Transmitter (ELT) system includes an ELT unit, an integral battery pack, warning buzzer, internal G-switch, antenna, remote switch, cable assembly, and antenna coaxial cable.

The ELT unit transmits on 121.5 MHz and 406.028 MHz.

The battery pack has two D-size lithium cells mounted under a battery cover. Replace the battery pack as necessary in the field.

The ELT activates a buzzer installed near the ELT assembly. The buzzer makes a loud noise to let people know that the ELT is on.

## ARTEX ME406 ELT DESCRIPTION AND OPERATION - (25-60-01)

The G-switch internally installed in the ELT transmitter, activates with a sudden reduction in forward speed.

### Artex ELT Antenna

The ELT system uses an antenna to transmit the emergency locator signal. The ELT antenna is installed on top of the tailcone skin forward of the vertical stabilizer. The ELT antenna connects to the ELT unit inside the dorsal with coaxial cable .

### ELT Remote Switch.

The ELT remote switch is installed on the right cockpit panel. The ELT remote switch is a two-position rocker switch that can be set in the ARM or the ON positions. When operating in a remote area or over hazardous terrain, it is recommended that the ELT be inspected by an approved technician more frequently than required by 14 CFR 91.207.

### NORMAL OPERATION

Check that the remote switch is set to the ARM position. Normal operation of the ME406 from the flight crew station is only to de-energize and arm the ELT after it has been accidentally energized (no emergency). A lightning strike or hard landing can energize the ELT.

If the red light above the remote switch is flashing and the aural warning is heard, the ELT is energized. Check for the emergency signal on a COM radio set to 121.5 MHz.

To stop the transmissions, set the remote switch to ON momentarily and then set to the ARM position. Tell the nearest Air Traffic Control facility about the accidental transmissions as soon as possible to hold search and rescue work to a minimum.

### PERFORMANCE

With the Artex ME406 ELT installed there is no change to the airplane performance.

**ARTEX ME406 ELT DESCRIPTION AND OPERATION - (25-60-01)****FIRST FIVE MINUTES**

Operate the Emergency Locator Transmitter system only during the first five minutes of each hour.

If you must complete the functional test at a time other than the first five minutes of the hour, you must do the test with a direct connection to the ELT and a 30 dB attenuator. Refer to the FAA Advisory Circular AC-91-44A.

**FIVE SECONDS**

Do not operate the emergency locator transmitter for more than five seconds at a time. Do not operate the ELT again for 15 seconds.

The ELT will transmit a 406.028 MHz signal after the ELT is active for approximately 50 seconds. This signal is identified as a distress signal.

During an accident, the ELT activates automatically and transmits a standard swept tone on 121.5 MHz (emergency frequency). The 121.5 MHz signal continues until the ELT battery has expired.

Every 50 seconds for 440 milliseconds, the 406.028 MHz transmitter activates and sends a message to the satellite. The 406.028 MHz transmission continues for 24 hours and then stops.

During operation, the ELT receives electrical power from the ELT battery pack only.

## ARTEX ME406 ELT DESCRIPTION AND OPERATION - (25-60-01)

The ME406 transmitter unit is located in the tailcone along the right side behind the baggage compartment aft panel.

A panel on the ELT transmitter unit has an ARM/ON switch and a transmitter warning light.

The ELT installation uses two different warnings to tell the pilot when the ELT energizes.

- The aural warning is an unusual sound heard by the pilot.
- The visual flashing red light above the remote switch shows the pilot that the ELT is activated.

With the ME406 energized, the ELT transmits the standard swept tone signal on the international VHF frequency of 121.5 MHz until battery power is gone. The 121.5 MHz signal is used to pinpoint the beacon during search and rescue operations, and is monitored by general aviation, commercial aircraft, and government agencies. In addition, for the first 24 hours with the ELT being energized, a 406.028 MHz signal transmits at 50 second intervals. This transmission lasts 440 milliseconds and contains identification data programmed into the ELT and is received by COSPAS/SARSAT satellites. The transmitted data may include the Aircraft ID, ELT Serial Number, Country Code, and COSPAS/SARSAT ID.

### OPERATING LIMITATIONS

There are no additional airplane operating limitations when the Artex ME406 ELT is installed.

The airplane owner or operator must register the ME406 ELT with the applicable civil aviation authority before use to make sure that the identification code transmitted by the ELT is in the COSPAS/SARSAT database.

- Refer to [www.cospas-sarsat.org](http://www.cospas-sarsat.org) for registration information.
- Refer to 14 CFR 91.207 for ELT inspection requirements.

Using the correct test equipment under the appropriate civil aviation authorities approved conditions, have the ME406 inspected and tested by an approved technician.

## ARTEX ME406 ELT DESCRIPTION AND OPERATION - (25-60-01)

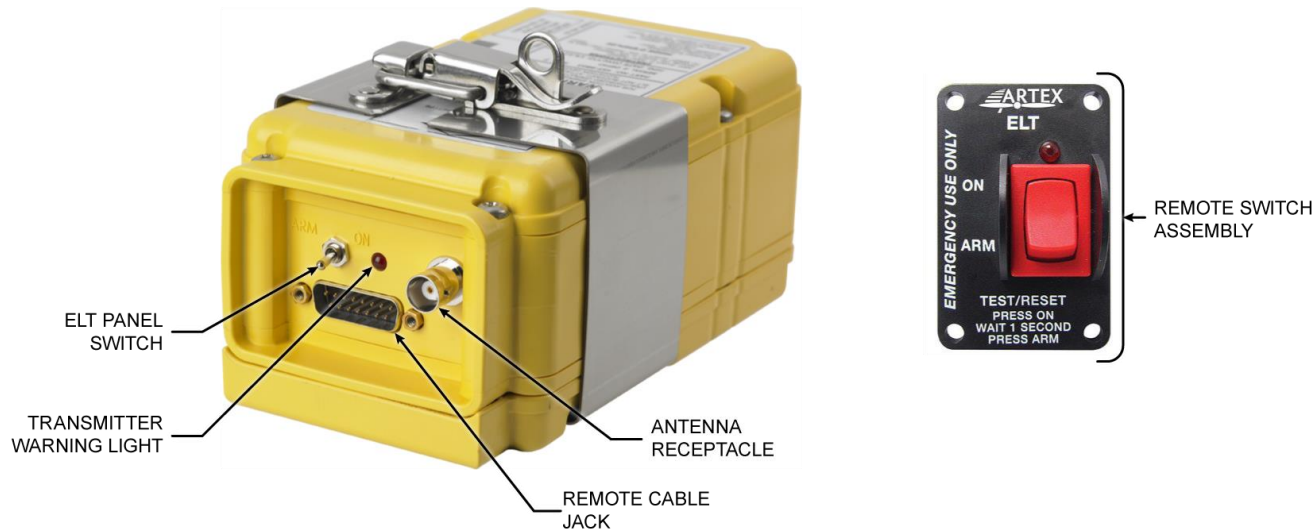
**ELT PANEL SWITCH (Two-Position Toggle Switch):**

- ARM (OFF) - Turns OFF and ARMS transmitter for automatic activation if “G” switch senses a predetermined deceleration level.
- ON - Activates transmitter instantly. The ON position bypasses the automatic activation switch.
- The RED warning light on the ELT panel and on the remote switch assembly mounted on the instrument panel should come on.
- **TRANSMITTER WARNING LIGHT**
  - Light comes on RED to indicate the transmitter is transmitting a distress signal.
- **ANTENNA RECEPTACLE**
  - Connects to the antenna mounted on top of tailcone.



## ARTEX ME406 ELT DESCRIPTION AND OPERATION - (25-60-01)

- **REMOTE CABLE JACK**
  - Connects to the ELT remote switch assembly located on the upper right instrument panel.
- **REMOTE SWITCH ASSEMBLY - (Two-Position Rocker Switch):**
  - The RED warning light above the rocker switch comes on to indicate that the transmitter is transmitting a distress signal.

## ARTEX ME406 EMERGENCY LOCATOR TRANSMITTER - SELF TEST (25-60-02)

This section contains the information needed to complete the self-test for the Artex ME406 ELT system. The system transmits on two frequencies at the same time.

Prepare the Airplane for the ME406 Emergency Locator Transmitter Troubleshooting

- Perform ELT 121.5 MHz Test.
- Tune the receiver (usually the aircraft radio) to 121.5 MHz.
- Set the ELT instrument panel remote switch to the ON position and wait for 3 sweeps on the receiver, which takes about 1 second.
- Set the remote switch back to the ARM (OFF) position immediately and the switch LED and buzzer will give 1 pulse.

**ARTEX ME406 EMERGENCY LOCATOR TRANSMITTER - SELF TEST (25-60-02)****CAUTION****FIRST FIVE MINUTES**

Operate the Emergency Locator Transmitter system only during the first five minutes of each hour.

If you must complete the functional test at a time other than the first five minutes of the hour, you must do the test with a direct connection to the ELT and a 30 dB attenuator. Refer to the FAA Advisory Circular AC-91-44A.

**CAUTION****FIVE SECONDS**

Do not operate the emergency locator transmitter for more than five seconds at a time. Do not operate the ELT again for 15 seconds.

The ELT will transmit a 406.028 MHz signal after the ELT is active for approximately 50 seconds. This signal is identified as a distress signal.

ARTEX ME406 ELT - INSPECTION / CHECK (25-60-01)



← ANTENNA

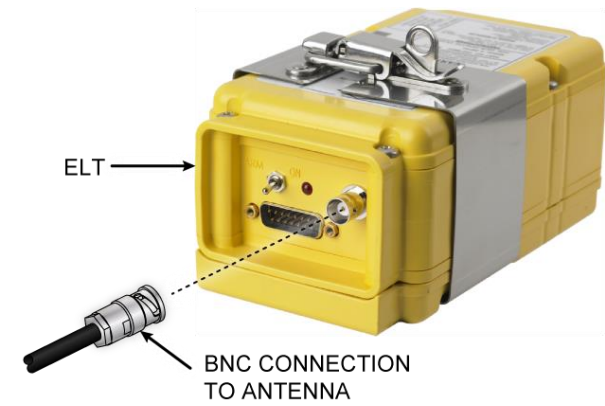

← ELT

← BNC CONNECTION TO ANTENNA



← COVER

## ARTEX ME406 ELT - INSPECTION / CHECK (25-60-01)

- The system transmits on two frequencies.
  - The 121.5 MHz frequency has the standard swept tone that rescue personnel can follow to the source.
  - The other frequency is 406.028 MHz and used to activate a satellite tracking system. The 406.028 MHz frequency includes other information such as the country code of the airplane, the aircraft identification beacon serial number, the 24-bit address, the tail number, or other identification.
- **Artex ME406 emergency locator transmitter (ELT) inspection**
  - Gain access to the ELT.
  - Perform an inspection of the ELT, mounting tray, antenna, and the ELT battery for condition and correct installation.
  - Examine the ELT and the mounting tray for correct installation, cleanliness, cracks, or other damage.
  - Examine the ELT battery for corrosion. Look at the battery expiration date.
  - Examine the ELT antenna for correct installation and cracks or other damage.
  - Install the ELT into the mounting tray.
- **Artex ME406 emergency locator functional test**
  - Perform a G-Switch operational test.
  - Perform a transmitter test of the Artex ME406 ELT system.
  - Have another person use the SARSAT tester set to the RECV function.
  - Install the 30 dB attenuator between the ELT and SARSAT tester if necessary.
  - Set the ELT remote switch on the right panel to the ON position.

**ARTEX ME406 ELT - INSPECTION / CHECK (25-60-01)**

- Let the ELT make three sweeps on the airplane speakers.
- Set the ELT remote switch back to the ARM position and monitor the LED.
- If the LED continues to flash, refer to Artex ME406 emergency locator transmitter system troubleshooting.
- If the SRSAT tester did not receive a 406.028 MHz signal and the ELT remote switch LED does not show a transmitter problem, do the test again.

**SOLVENTS**

Do not use solvents to clean the ELT, mounting tray, or electrical contacts. Solvents used in these areas can cause damage to the ELT housing.

**BATTERY LIFE LIMIT**

The battery manufacturer puts a mark on the battery to show the battery life limit. When you install a new battery in an ELT, make sure a record of the expiration date is in the space given on the ELT name and data plate.

**ARTEX ME406 ELT - INSPECTION / CHECK (25-60-01)****TEST PROCEDURE**

If possible, do the test procedure for the emergency locator transmitter inside a metal hangar with the doors closed to decrease the signal transmission from the ELT unit during the test.

**EXPERIENCED TECHNICIAN**

Ensure that an experienced technician does this procedure because of the potential physical damage that can occur if the jumper wire is not installed correctly.

**ARTEX ME406 ELT - INSPECTION / CHECK (25-60-01)****NOTE****JUMPER WIRE**

The ELT will not activate with the G-switch unless electrical pins 12 and 13 have a jumper wire installed between them (this happens automatically when the ELT locks into the mount tray with the electrical connector in position).

Because of the potential physical damage that can occur if the jumper wire is not installed correctly, it is recommended that an experienced technician do this procedure.

**NOTE****TEST EQUIPMENT**

The SARSAT tester is used as an example to gather test information. However, other equivalent test equipment such as the Aeroflex IFR 4000 Communications Test Set is acceptable.

**ARTEX ME406 ELT - INSPECTION / CHECK (25-60-01)****CAUTION****FIVE MINUTES**

Operate the Emergency Locator Transmitter (ELT) system only during the first five minutes of each hour. If you must complete the functional test at a time other than the first five minutes of the hour, you must do the test with a direct connection to the ELT and a 30 dB attenuator. Refer to the FAA Advisory Circular AC-91-44A.

**CAUTION****FIVE SECONDS**

Do not operate the emergency locator transmitter for more than five seconds at a time. Do not operate the ELT again for 15 seconds.

The ELT will transmit a 406.028 MHz signal after the ELT is active for approximately 50 seconds. This signal is identified as a distress signal.



**ARTEX ME406 ELT - INSPECTION / CHECK (25-60-01)****NOTE****TEST EQUIPMENT**

The SARSAT tester is used as an example to gather test information. However, other equivalent test equipment such as the Aeroflex IFR 4000 Communications Test Set is acceptable.

**NOTE****SARSAT TESTER**

The SARSAT tester must be less than 15 feet from the ELT antenna and must have a line-of-sight between the ELT antenna and SARSAT tester.

**ARTEX ME406 ELT - INSPECTION / CHECK (25-60-01)****NOTE****ELT BUZZER**

The person with the SARSAT tester must make sure that they hear the ELT buzzer during the test.

**NOTE****TRANSMITTER TEST**

If it is necessary to do the transmitter test after the first five minutes of the hour, the SARSAT tester connects directly to the ELT with a coaxial cable and a 30 dB attenuator. You will not hear the sweep tone from the ELT on the airplane speakers with the attenuator installed.

**ARTEX ME406 ELT - INSPECTION / CHECK (25-60-01)****ELT SELF TEST**

The ELT will do a self-test. The LED will stay on for one second and the ELT sweeps are not audible on the airplane speakers if the ELT operation is normal.

**TEST SIGNAL**

The ELT does not transmit a 406.028 MHz test signal to the SARSAT tester until the ELT remote switch is set back to the ARM position.

**ARTEX ME406 ELT - INSPECTION / CHECK (25-60-01)****NOTE****REGISTRATION**

When ownership of an aircraft changes within the same country, the ME406 ELT should be reregistered with the applicable authority. When an aircraft with a ME406ELT changes tail number or country registration, the ELT will need to have the new identification data entered. The ELT will also need to be registered with the applicable authority.

# CARBON MONOXIDE DETECTOR - MAINTENANCE PRACTICES (25-60-10)

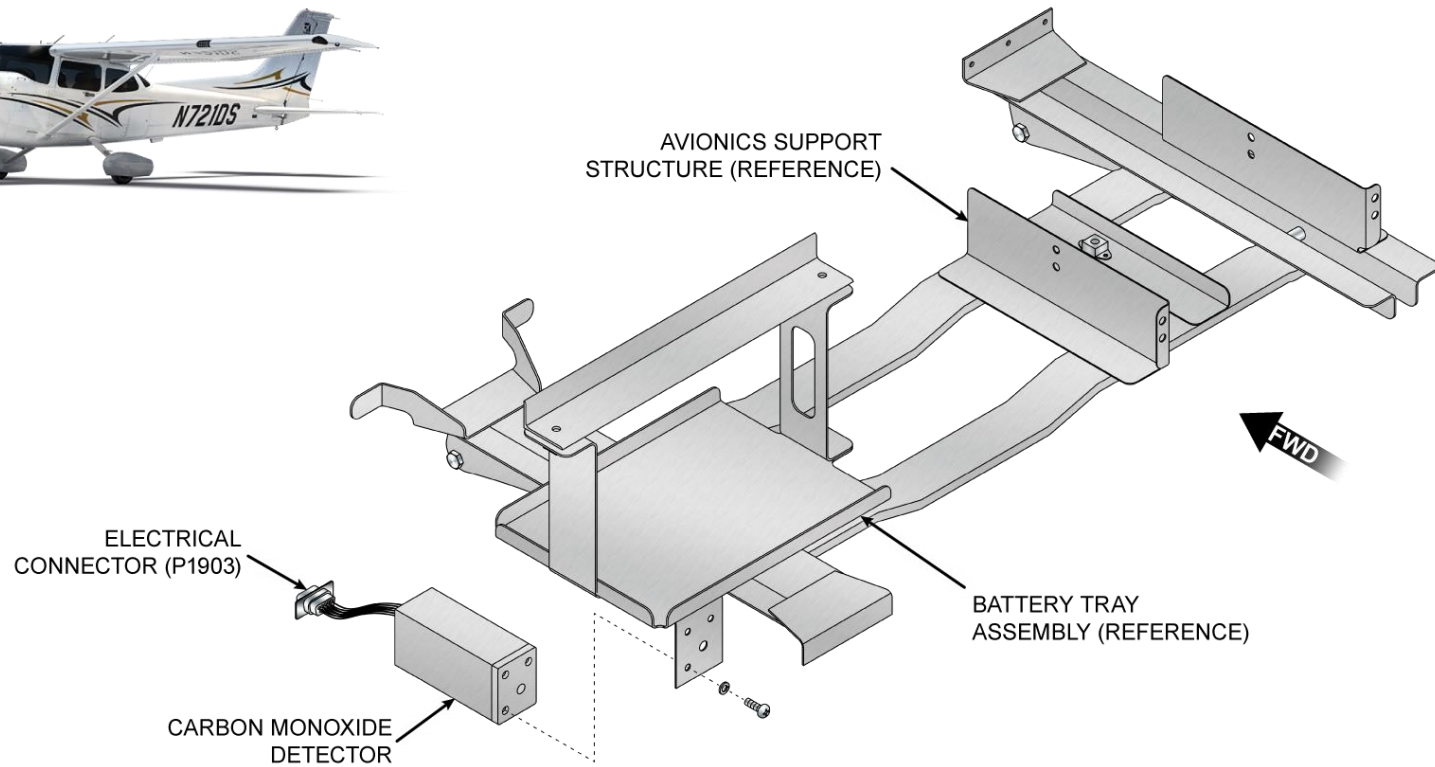

	<b>CARBON MONOXIDE</b>
	Carbon monoxide (CO) is a colorless, odorless, tasteless product of an internal combustion engine and is always present in exhaust fumes.
	Even minute quantities of carbon monoxide breathed over a long period of time may lead to dire consequences.

The symptoms of carbon monoxide poisoning are difficult to detect by the person affected and may include blurred thinking, a feeling of uneasiness, dizziness, headache, and loss of consciousness.

The CO detector detects, measures, and gives an alert to the crew before the cockpit level of CO reaches a critical level.

The carbon monoxide (CO) detection system has a single detector located behind the instrument panel, powered by the airplane's DC electrical system and integrated in the Garmin G1000 system with a warning annunciation and alert messages displayed on the PFD.

When the CO detection system senses a CO level of 50 parts-per-million (PPM) by volume or greater, the alarm turns on a flashing warning annunciation, **CO LVL HIGH**, in the annunciation window on the PFD with a continuous tone until the PFD softkey below WARNING is pushed. It remains on steady until the CO level drops below 50 PPM and automatically resets the alarm.

If the CO system detects a problem within the system that requires service, a **CO DET SRVC** message displays in the alerts window of the PFD.

If there is an interface problem between the G1000 system and the CO system a **CO DET FAIL** message displays in the alerts window of the PFD.

## **ATA26 Fire Protection**

### **FIRE PROTECTION SYSTEM OVERVIEW**

- Fire Protection - Description and Safety
- Fire Protection - Operation

## FIRE PROTECTION - DESCRIPTION AND SAFETY (26-20-00)

A portable, hand-operated fire extinguisher is mounted on the floor between the pilot and copilot seats for use in the event of a fire.

Servicing of the extinguisher can be handled by most fire equipment dealers.

The fire extinguisher is mounted within a quick release, clamp type bracket assembly.

The extinguishing agent is Halon 1211 and may be used on solid combustible, electrical or liquid fires. The extinguisher should be checked prior to each flight to ensure that the pressure of the contents, as indicated by the gage at the top of the extinguisher, is within the green arc (approximately 125 psi) and the operating lever lock pin is securely in place.



The extinguisher is classified 5B:C by Underwriters Laboratories. What this means broken down is:

**Class 5** - is the rating for how much fire the extinguisher can put out over time.

**Class B** - used for FLAMMABLE LIQUIDS & GASES (gasoline, oils, paint lacquer and tar)

**Class C** - used for FIRES INVOLVING LIVE ELECTRICAL EQUIPMENT



## FIRE PROTECTION - DESCRIPTION AND SAFETY (26-20-00)



### VENTILATE THE CABIN

Ventilate the cabin promptly after successfully extinguishing the fire to reduce the gases produced by thermal decomposition.

Fire extinguishers should be recharged by a qualified fire extinguisher agency after each use. After recharging, secure the extinguisher to its mounting bracket.

## FIRE PROTECTION - OPERATION (26-20-00)



When it's time to use a **FIRE EXTINGUISHER**,  
remember **PASS**:

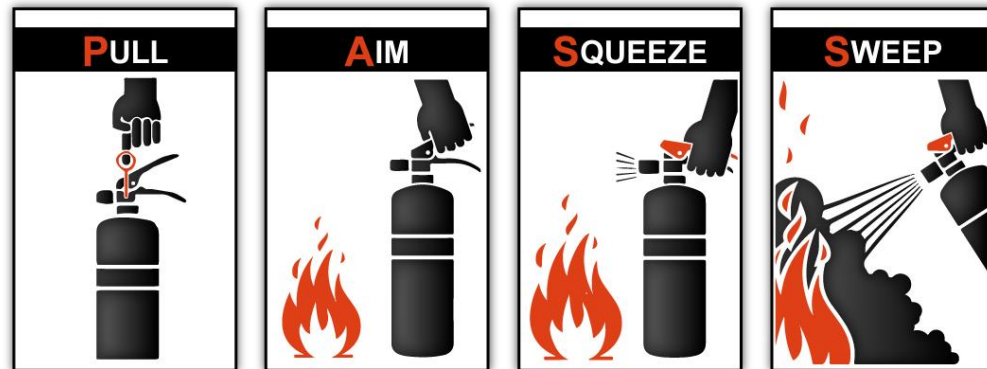

To operate the fire extinguisher:

- Loosen retaining clamp(s) and remove extinguisher from bracket.
- Hold extinguisher upright, pull operating ring pin, and press lever while directing the liquid at the base of the fire at the near edge. Progress toward the back of the fire by moving the nozzle rapidly with a side-to-side sweeping motion.
- The contents of the cabin fire extinguisher will empty in approximately eight seconds of continuous use.

Equipment & Furnishings/Fire Protection Review

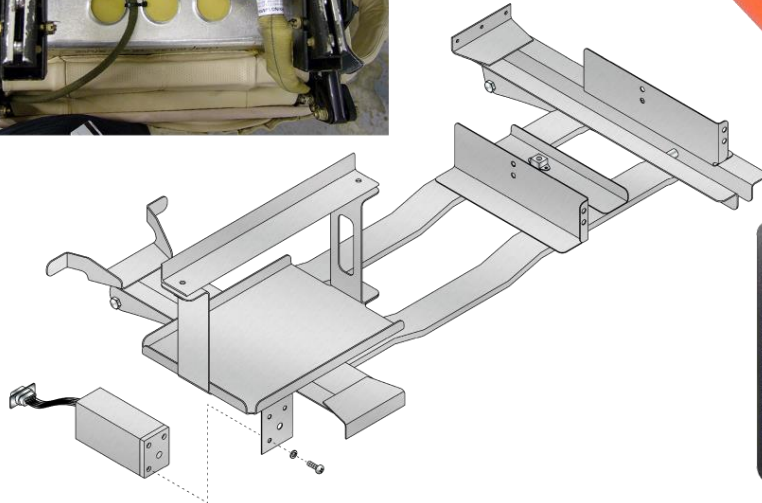

## Model Differences

### 182/206 DIFFERENCES - INFLATABLE RESTRAINT 25-11-10 (182) & 25-10-10 (206)

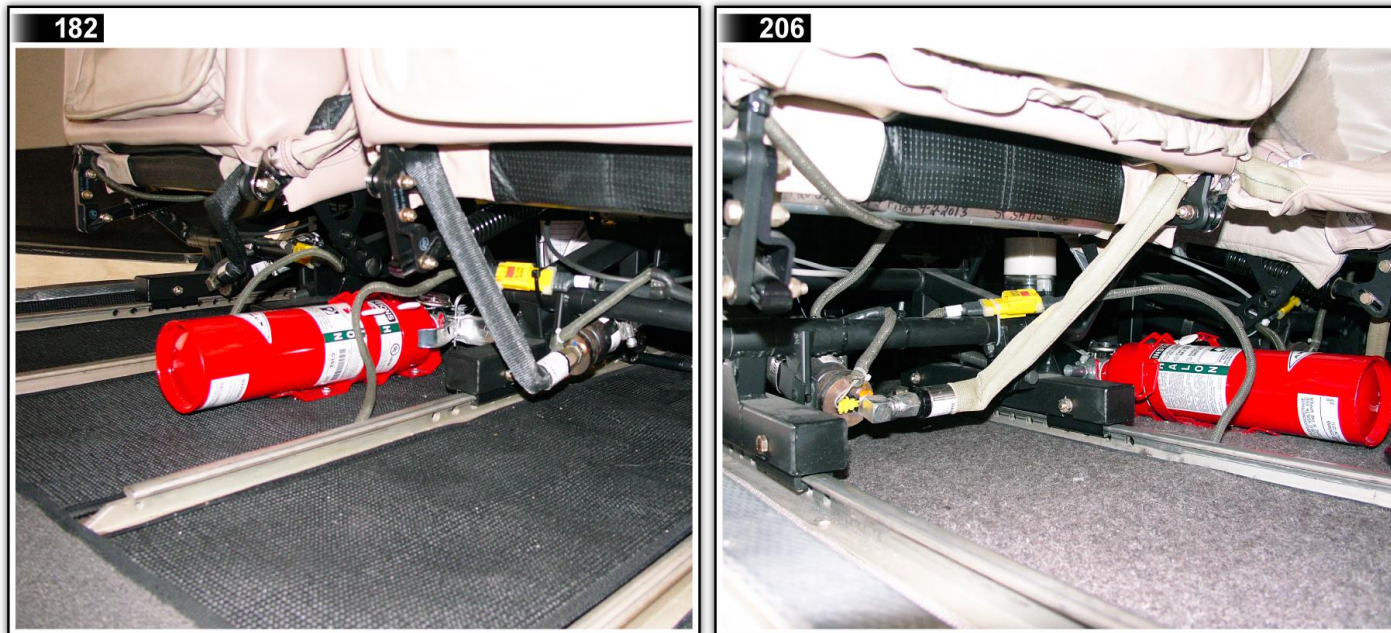

Inflatable restraints are located under the crew seats on each aircraft.

#### Maintenance practices for the 182 and 206

- 182 & 206 - Inflatable Restraint – Cleaning.
- 182 & 206 - Inflatable Restraint – Inspection.
- 182 & 206 - Storage of Spares.
- 182 & 206 - AMSAFE Inflatable Restraint Disarm/Arm.
- 182 & 206 - Inflatable Restraint System - Removal/Installation.
- 182 & 206 - AMSAFE Aviation Inflatable Restraint (AAIR) System Adjustment/Test.



**182/206 DIFFERENCES - INFLATABLE RESTRAINT 25-11-10 (182) & 25-10-10 (206)****MAXIMUM CONTINUOUS STORAGE TIME**

- (182 & 206) The maximum continuous storage time for the inflator assembly is seven years from the date of manufacture. After seven years, send the inflator assembly to AMSAFE Aviation for inspection and repair.
- (182 & 206) The maximum continuous storage time for the EMA is seven years from the date of manufacture. After seven years, send the EMA to AMSAFE Aviation for inspection and repair.

**MAXIMUM ALLOWABLE RESISTANCE**

There are two seats in each AAIR system. This functional test must be completed for each AAIR system on the airplane.

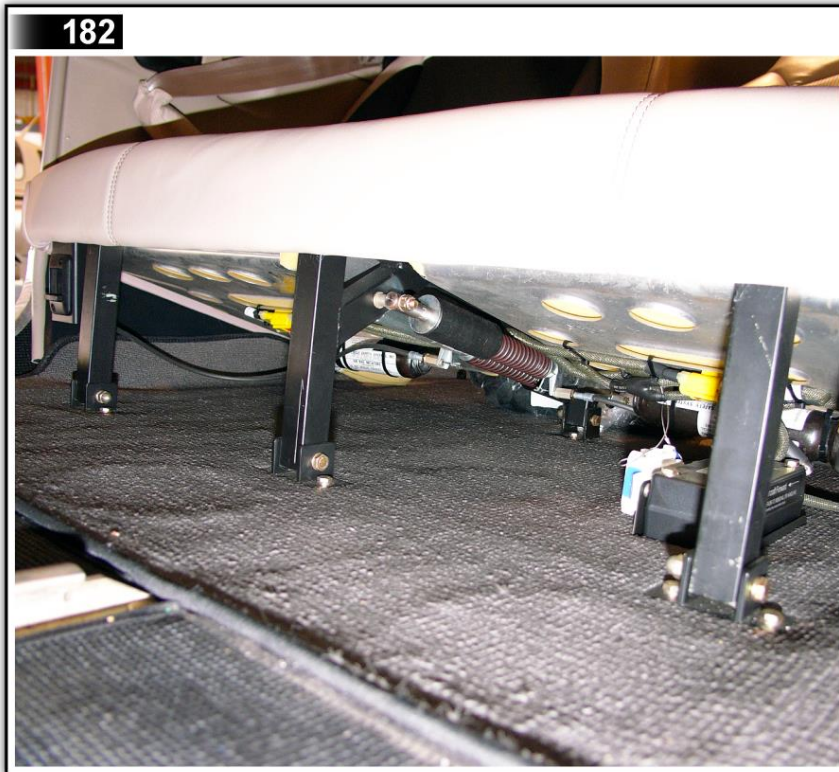
**182/206 Differences - Rear Seat 25-21-00**

Refer to the Maintenance Manual (25-00-00) for a list of tools, equipment, and materials required to maintain the airplane interior and emergency equipment.

**182 & 206 Rear Seat Removal/Installation**

- Remove restraints prior to seat removal.
- Remove bolts securing seat frame to fuselage.
- Remove seat from airplane.
- Rear Seat Installation
- Install seat to fuselage and secure using bolts.
- Install restraints.

## ARTEX C406-N ELT - (25-60-01)

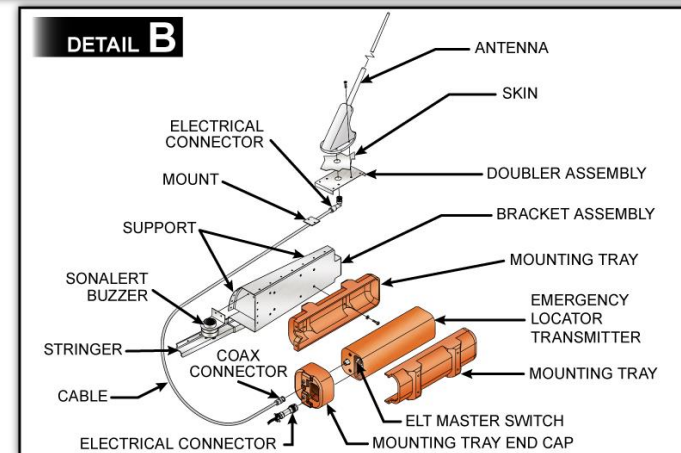
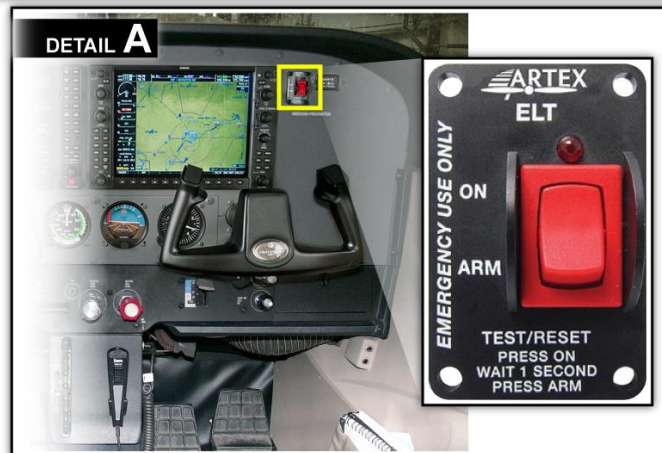
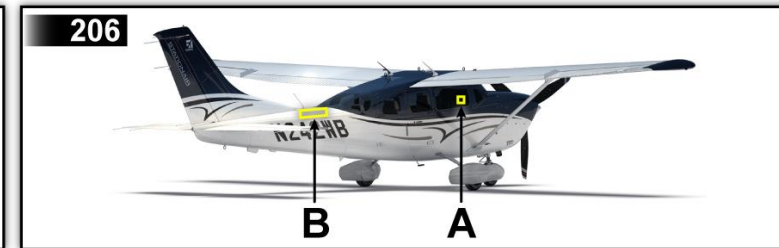
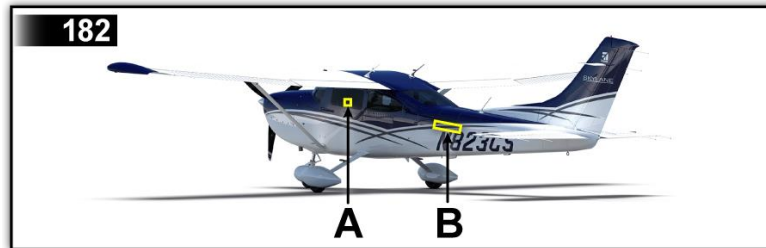

Like the 172, the aircraft can have either the C406-N ELT or the ME406 installed, depending on customer requirements and needs.

### 182/206 Maintenance Practices

- Artex C406-N ELT Removal/Installation
- Artex C406-N Buzzer Removal/Installation
- Artex C406-N ELT Remote Switch Removal/Installation
- ELT Rod Antenna Removal/Installation



**ARTEX C406-N ELT - (25-60-01)****MAXIMUM ALLOWABLE RESISTANCE**

The maximum allowable resistance (in ohms) at each of the four measured positions is 0.0025.

**DIRECTION OF FLIGHT ARROW**

For the 182 and 206 - make sure that the direction-of-flight arrow on the elt points to the nose of the airplane.

- Do a functional test of the ELT. Refer to Artex C406-N ELT Functional Test.

**182 AND 206 ARTEX ME406 ELT LOCATION DIFFERENCES - (25-60-02)**

On the 182, the location of the ARTEX ME406 ELT is on the LEFT side of the fuselage aft of the rear cargo area.

The 172 is on the RIGHT side of the fuselage above the rear cargo area.

On the 206, the location is different from the 172 and 182. (Right photo)

**182/206 Maintenance Practices:**

- Emergency Locator Transmitter (ELT) Removal/Installation
- ELT Buzzer Removal/Installation
- Remote Switch Removal/Installation
- ELT Antenna Removal/Installation
- Do a functional test of the ELT system. Refer to Artex ME406 Emergency Locator Transmitter - Adjustment/Test.

